



SITESCAPES

P.O. Box 22326
Lincoln, NE 68542

PF: 402/421-9464
FX: 402/421-9479

WEBSITE: www.sitescapesonline.com
E-MAIL: info@sitescapesonline.com

TITLE

*NEWCASTLE
BENCH*

PRODUCT NO.

NC1-1000

INCH TOLERANCES U.O.S.

FRACTION-- $\pm 1/16"$
ANG----- $\pm 1^\circ$

THE INFORMATION CONTAINED IN THIS DRAWING IS THE SOLE PROPERTY OF SITESCAPES, INC. ANY REPRODUCTION IN PART OR AS A WHOLE WITHOUT THE WRITTEN PERMISSION OF SITESCAPES, INC. IS PROHIBITED.

*Available in powder coat and DuraCoat finishes

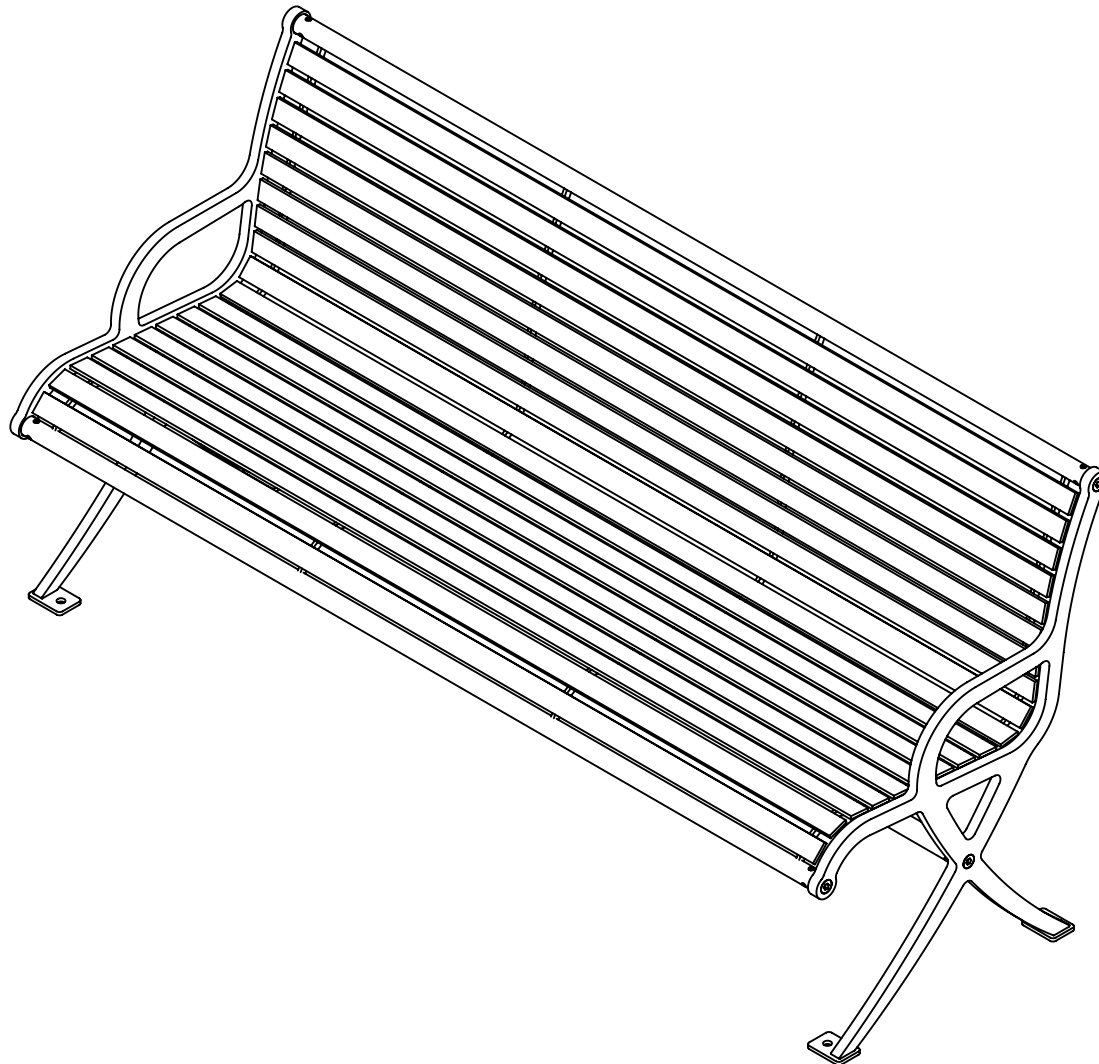



SITESCAPES

P.O. Box 22326
Lincoln, NE 68542

PF: 402/421-9464
FX: 402/421-9479

WEBSITE: www.sitescapesonline.com
E-MAIL: info@sitescapesonline.com

TITLE
**NEWCASTLE
BENCH**

PRODUCT NO.
NC1-1000

INCH TOLERANCES U.O.S.
FRACTION-- $\pm 1/16"$
ANG----- $\pm 1^\circ$

THE INFORMATION CONTAINED IN THIS DRAWING IS THE SOLE PROPERTY OF SITESCAPES, INC. ANY REPRODUCTION IN PART OR AS A WHOLE WITHOUT THE WRITTEN PERMISSION OF SITESCAPES, INC. IS PROHIBITED.

*Available in powder coat and DuraCoat finishes

MATERIALS LIST:

- (1) Bench Ends - 3/4" Laser-Cut Steel Plate
- (2) Seat Straps - 1 1/2" x 3/16" Steel Flat Bar
- (3) Support Tubes - 1" Sch. 40 Steel Pipe
- (4) Foot Plates - 1/4" Stainless Steel Plate
- (5) Mounted with Four $\phi 1/2"$ x 4-5" Stainless Steel Anchor Bolts (Customer Supplied)

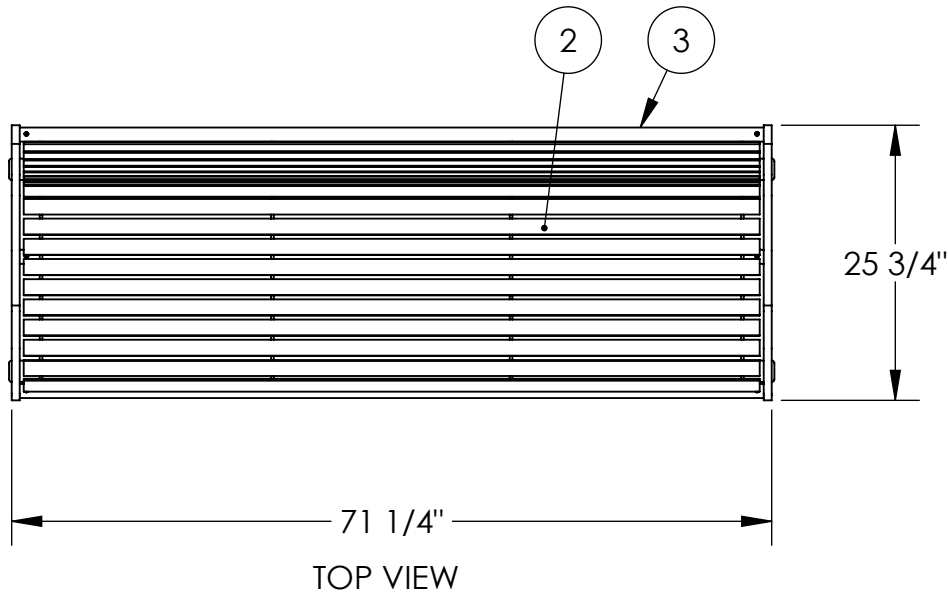

TOP VIEW

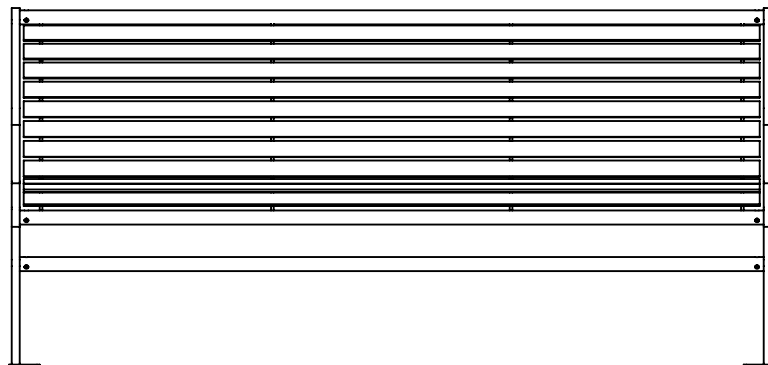

FRONT VIEW

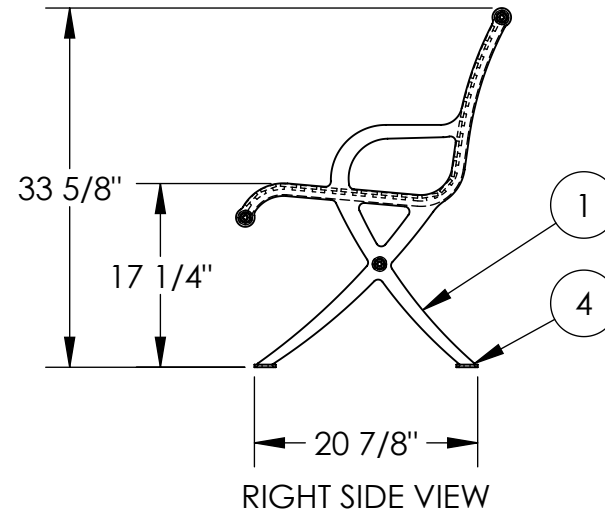

RIGHT SIDE VIEW

